

LYBRA S

SEMI AUTOMATIC PALLET WRAPPER
MAINTENANCE FREE
EASY INSTALLATION

Semi Automatic Rotary Arm Stretch Wrapper



LYBRA

Input: 230 Volt
1 PHASE



NEW PANEL, NEW SOLUTIONS

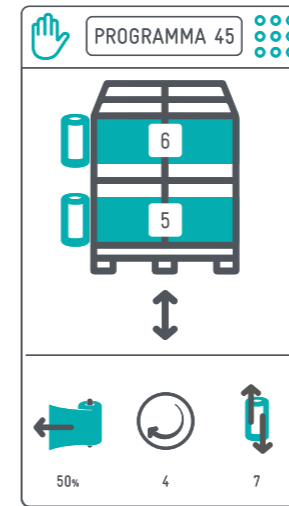

USER FRIENDLY EXPERIENCE

- IT** Il nuovo pannello touch da 7 pollici, l'utente ha un nuovo modo di impostare i programmi per il miglior risultato di avvolgimento.
- EN** New 7-inch touch panel, challenge the user to setup an explore ways, for the best wrapping result.
- FR** Le nouvel écran touch de 7 pouces, l'utilisateur dispose d'une nouvelle façon de régler les programmes pour le meilleur résultat d'emballage.
- DE** Mit dem neuen 7-Zoll-Touchpanel hat der Benutzer eine neue Möglichkeit, Programme für das beste Wickelergebnis einzustellen.
- ES** El nuevo panel touch de 7 pulgadas, el usuario tiene una nueva forma de configurar los programas para obtener el mejor resultado de envoltura.

ARYA SYSTEM

- IT** Brevetto rivoluzionario che porta l'automazione a portata di mano senza investimenti significativi.
- EN** Revolutionary patent which brings automation within reach without significant investments.
- FR** Un modèle révolutionnaire qui met l'automatisation à portée de main sans investissements importants.
- DE** Revolutionäres Patent, das die Automatisierung ohne erhebliche Investitionen in greifbare Nähe rückt.
- ES** Patente revolucionaria que pone la automatización al alcance sin inversiones significativas.

PALLET DIMENSIONS

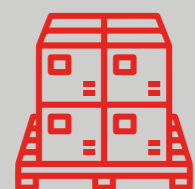
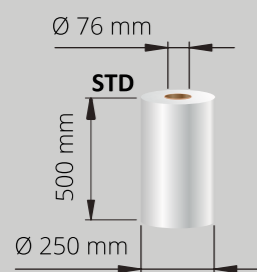

H mm Lybra
2200 STD
2500 OPT
3000 OPT

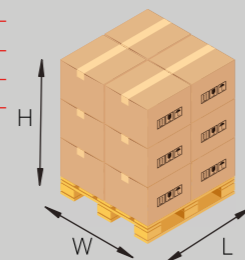

WxL mm	MAX Ø mm
1200x1200	1700 STD
1400x1400	1980 OPT
1500x1500	2120 OPT
1600x1600	2260 OPT
1700x1700	2400 OPT

APPLICATIONS





ATLANTA STRETCH SELLING POINTS

ERGONOMIC SOLUTION FOR THE USER

- IT** L'attenzione alla sicurezza e al massimo comfort del lavoratore contribuiscono a migliorare la qualità del lavoro, diminuendo lo stress a favore della soddisfazione generale dell'utente
- EN** For the highest security and safety of the user and to achieve a better working, and higher satisfaction of the user.
- FR** Pour la plus grande sécurité et sûreté de l'utilisateur et pour obtenir un meilleur environnement de travail et une plus grande satisfaction de l'utilisateur.
- DE** Für höchste Sicherheit des Nutzers, sowie zur Erreichung eines besseren Arbeitsumfelds und Zufriedenheit
- ES** Para la mayor seguridad y protección del usuario, mejor calidad de trabajo y una mayor satisfacción del usuario.



- IT** La facilità con cui i nostri componenti sono reperibili sul mercato contribuisce ad abbatterne il prezzo con notevole risparmio per l'utente.
- EN** The use of commercial components in all our products means higher reliability and lower costs but also flexibility in terms of spare parts.
- FR** La façon dont nous nous approvisionnons et spécifions des niveaux élevés pour les composants de nos produits, signifie que vous bénéficierez de niveaux de fiabilité élevés et constants
- DE** Der Einsatz handelsüblicher Komponenten in all unseren Produkten bedeutet höhere Zuverlässigkeit und geringere Kosten, aber auch Flexibilität bei der Materialversorgung.
- ES** El uso de componentes comerciales en todos nuestros productos significa mayor confiabilidad y menores costos, pero también flexibilidad en términos de suministro de repuestos.



POSSIBILITY TO ADJUST TENSION ON LOAD AND PRE STRETCH IN EVERY STEP OF THE WRAPPING CYCLE

- IT** I nostri carrelli offrono la possibilità di regolare in maniera mirata la tensione del film e il pre-stretch in ogni fase dell'avvolgimento.
- EN** Our carriages are standard equipped with the possibility to adjust film tension and pre-stretch during every phase of the wrapping process.
- FR** Nos chariots sont tous équipés en mode standard avec la possibilité de régler la tension du film et de le pré-étirer à chaque étape du processus d'emballage.
- DE** Unsere Folienschlitten sind so konzipiert, dass sowohl die Anlegespannung als auch die Folienvordehnung in jeder Phase des Wickelzyklus regulierbar sind.
- ES** Nuestros carros están equipados de serie con la posibilidad de ajustar la tensión de la película y preestirar durante cada fase del proceso de envoltura.

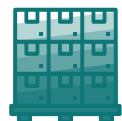

OPERATING PANEL

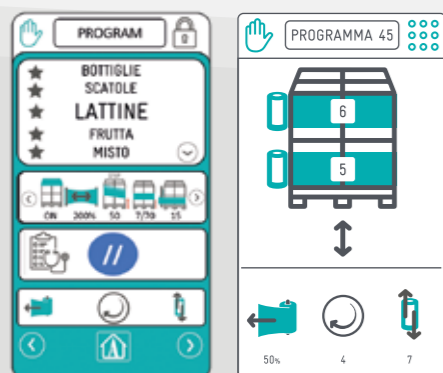

EASY TO USE 7" easy to use touch display

Lybra S

- IT** Imposta e avvia il tuo ciclo di avvolgimento con pochi semplici comandi.
- EN** Set and start your wrapping cycle with a few simple commands.
- FR** Réglez et démarrez votre cycle d'emballage avec quelques commandes simples.
- DE** Stellen Sie Ihren Verpackungszyklus mit ein paar einfachen Befehlen ein und starten Sie ihn.
- ES** Configure e inicie su ciclo de envoltura con unos simples comandos



MEANS OF LOADING

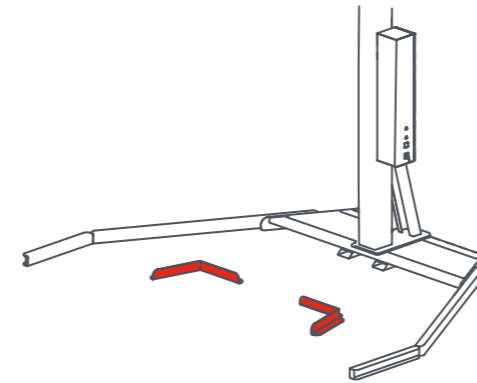

FLOOR MOUNTED GUIDES

- IT** Guida per centraggio automatico dei pallets.
- EN** Floor mounted guides to locate the pallet correctly are included.
- FR** Support de guidage pour une parfaite lecture de palette sont inclus.
- DE** Zum Lieferumfang gehört ebenfalls eine Palettenpositionierhilfe welche zeitgleich eine Kollision mit dem Dreharm ausschließt.
- ES** Soporte de guía para cargar correctamente la plataforma, incluidos en la entrega.



LYBRA S + ARYA SAVE TIME, SAVE MONEY

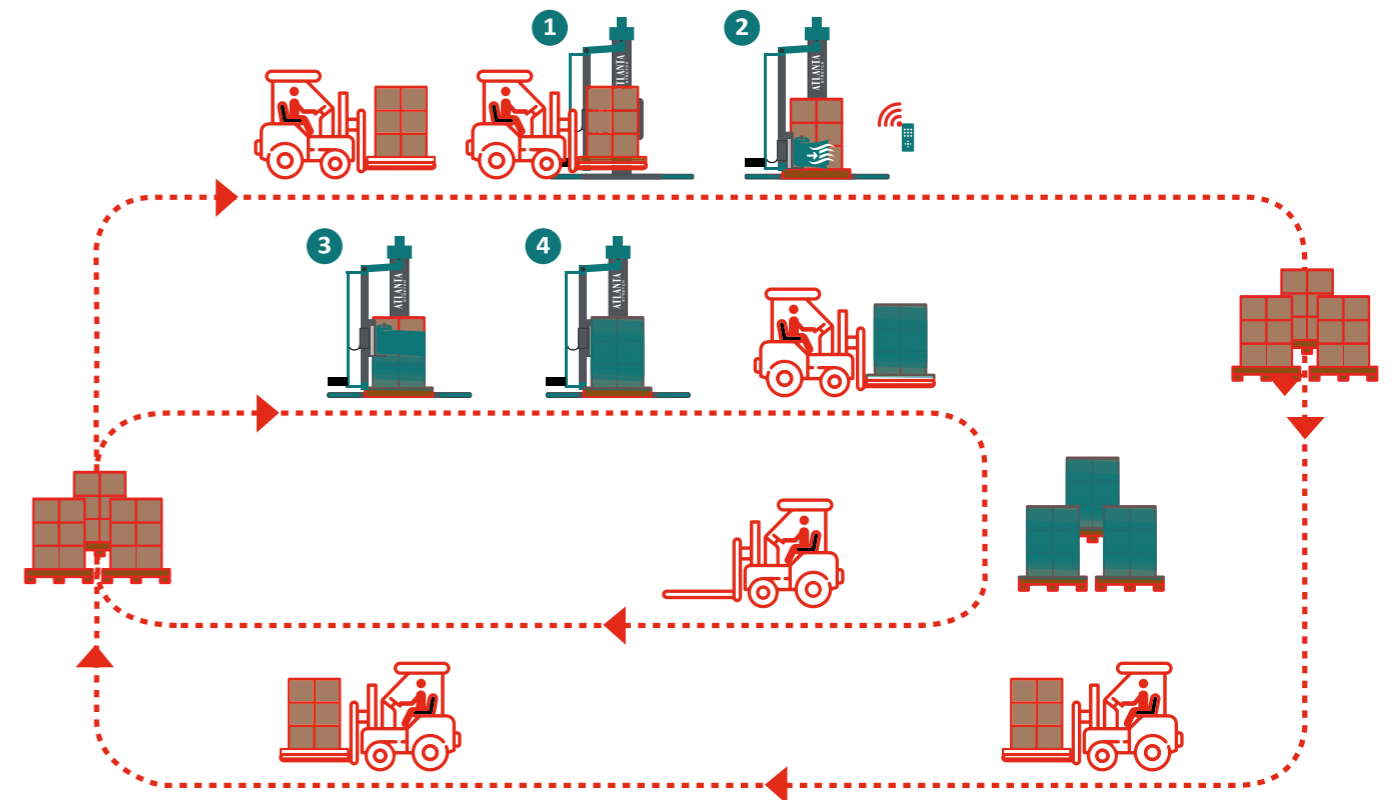

WRAPPING PROGRAMS

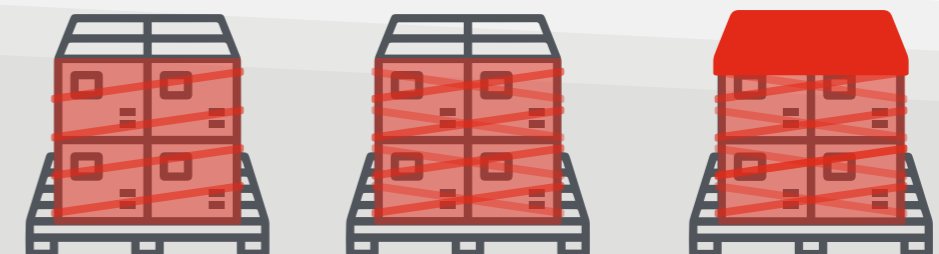



SPOOL FILM CARRIAGE

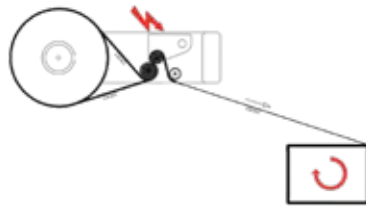

EASY FILM CHANGE

- IT** Cambio film semplificato, altezza di arresto del carrello porta bobina automatico.
- EN** Easy reel change, adjustable service height.
- FR** Changement de bobine facile, hauteur de service réglable.
- DE** Einfacher Folienwechsel in ergonomischer Arbeitshöhe.
- ES** Cambio fácil de bobina, altura de servicio ajustable.

FE

- IT** Frizione elettromagnetica regolabile da pannello comandi.
- EN** Electromagnetic friction adjustable from control panel.
- FR** Frein électromagnétique réglable depuis le panneau de commande.
- DE** Elektromagnetische Bremse auf Umlenkwalze vom Bedienpult instellbar.
- ES** Fricción electromagnética regulable desde el panel de comandos.

PRS POWER ROLLER STRETCH

- IT** Sistema di prestiro motorizzato a 3 rulli comandato elettronicamente con rapporti intercambiabili disponibili su richiesta: 150- 200- 250%.
- EN** Motorized pre-stretch system with 3 driven rollers electronically controlled with interchangeable ratios on request: 150- 200- 250%.
- FR** Système de pré-étirage motorisé et asservi à 3 rouleaux, rapports interchangeables disponible sur demande: 150- 200- 250%.
- DE** Angetriebener Vordehnssystem mit 3 Vordehnrollen, elektronisch gesteuert mit leicht wechselbarer Zahnradsätzen auf anfrage erhältlich: 150- 200- 250%.
- ES** Sistema de prestiro motorizado con 3 rodillos, comandado electrónicamente con desarrollos intercambiables disponible previa demanda: 150- 200- 250%.

PS POWER STRETCH

- IT** Sistema di motorizzato a 3 rulli con 2 motori e variazione da 120 a 350% regolabile da quadro comandi.
- EN** Motorized pre-stretch system with 3 driven rollers and 2 motors adjustable between 120 to 350% from control panel.
- FR** Système de pré-étirage motorisé et asservi à 3 rouleaux et 2 moteurs, rapport ajustable de 120 à 350% depuis le panneau de commande.
- DE** Angetriebener Vordehnssystem mit 3 Vordehnrollen und 2 Motoren, stufenlos regelbare Werte zwischen 120 und 350% von Bedienpult.
- ES** Sistema de prestiro motorizado con 3 rodillos y 2 motores, regulable de 120 a 350% desde el panel de comandos.

OPTIONALS

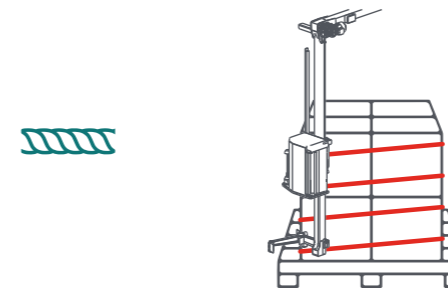
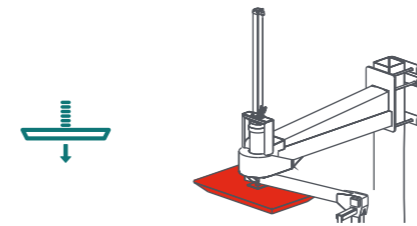
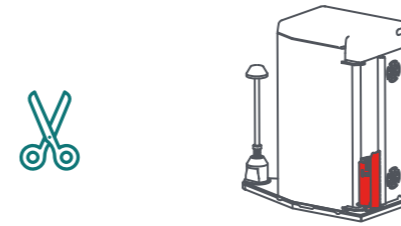

AUTOMATIC FILM CUT FOR FE AND OPRS CARRIAGES

- IT** Sistema di taglio automatico del film a fine ciclo.
- EN** Automatic Film cutting Device at cycle end.
- FR** Coupe automatique du film.
- DE** Automatische Folienschneidvorrichtung am Zyklusende.
- ES** Sistema automatico de corte del film al fin del ciclo.

TOP PRESSURE UNIT

- IT** Pressore tenuta pallet.
- EN** Pallet holder presser.
- FR** Plateu stabilisateur de charge.
- DE** Palettendruchhalter.
- ES** Prensor de retencion del palet.

ROPING SYSTEM

- IT** Sistema di cordatura film: Permette di ridurre l'altezza del film formando un cordone che assicura una più efficiente stabilizzazione del carico.
- EN** Roping System: Reducing the film width to form a rope to ensure more effective load stabilisation.
- FR** Systeme permettant de réduire la laize du film en formant un cordon qui assure une meilleure stabilisation de la charge.
- DE** Schnurrvorrichtung: Reduzierung der Folienbreite zur Schnur um eine bessere Stabilisierung der Ladung zu gewährleisten.
- ES** Sistema de Cordón: permite reducir el ancho del film formando un cordón que asegura eficientemente la estabilidad de la carga.

LOW TEMPERATURE MACHINE

- IT** -5°C versione frigorifero • -30°C versione freezer • versione inox
- EN** -5°C coldstore version • -30°C freezer version • inox version
- FR** -5°C version chambre froide • -30°C version congélateur • version inox
- DE** -5°C Kühlhausversion • -30°C Tiefkühlversion • Inox-Version
- ES** -5°C versión frigorífica • -30°C versión congelador • versión inox

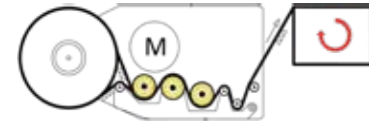

POSSIBILITY OF ARYA SYSTEM INSTALLATION

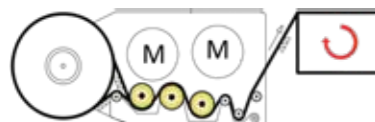

POSSIBILITY OF ARYA SYSTEM INSTALLATION

SEMI AUTOMATIC RANGE

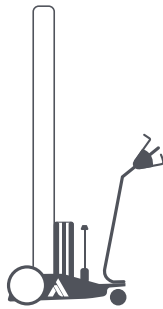

MARATHON

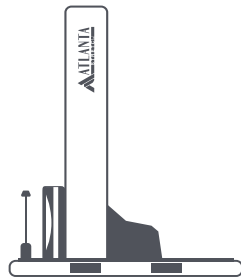

EVA

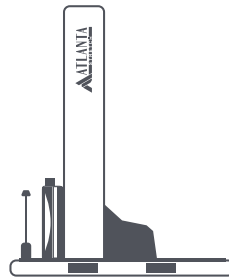

SYNTHESI

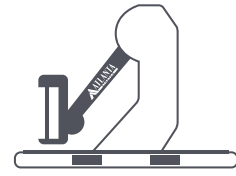

SYNTHESI ARM

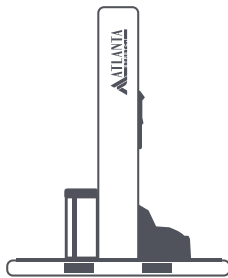

MYTHO S



SFERA ARM

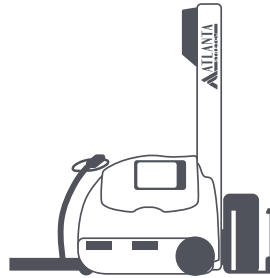

SFERA MAST



NEOS

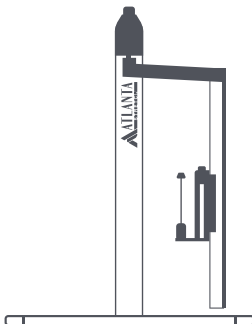

LYBRA EASY

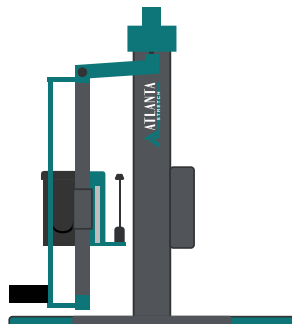

LYBRA S

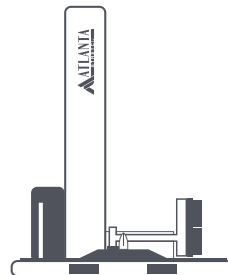

MYTHO AUTO

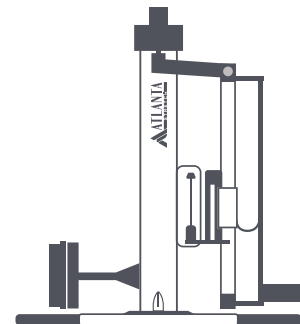

LYBRA AUTO

Atlanta Stretch Authorized dealer



Headquarter: Atlanta Stretch Italy Spa

Subsidiaries: Atlanta Stretch Australia - Atlanta Stretch China - Atlanta Stretch Deutschland - Atlanta Stretch France - Atlanta Stretch Iberica - Atlanta Stretch India - Atlanta Stretch Mexico - Atlanta Stretch Russia - Atlanta Stretch SEA - Atlanta Stretch Sweden - Atlanta Stretch Turkey - Atlanta Stretch UK



View all optional tools here

www.atlantastretch.com

Find out all our dealers

